

access

LIGHTING

INSTALLATION INSTRUCTIONS

IMPORTANT SAFETY INSTRUCTIONS

MESURES DE SECURITE A RESPECTER

Before assembling your ACCESS LIGHTING fixture, please make sure that you carefully read through this instruction sheet. Save this instruction sheet and refer to it when additions to or changes in the fixture configuration are made.

Lisez attentivement ce manuel d'instructions. Enregistrer cette feuille d'instructions et de s'y référer lorsque les ajouts ou changements dans la configuration de montage sont faites.

CONSULT A QUALIFIED ELECTRICIAN TO ENSURE CORRECT BRANCH CIRCUIT CONDUCTOR.

CONSULTER UN ELECTRICIEN QUALIFIE POUR VOUS ASSURER QUE LES CONDUCTEURS DE LA DERIVATION SONT ADEQUATS

THIS PRODUCT MUST BE INSTALLED IN ACCORDANCE WITH THE APPLICABLE INSTALLATION CODE BY A PERSON FAMILIAR WITH THE CONSTRUCTION AND OPERATION OF THE PRODUCT AND THE HAZARDS INVOLVED.

CE PRODUIT DOIT ETRE INSTALLE SELON LE CODE D'INSTALLATION PERTINENT, PAR UNE PERSONNE QUI CONNAIT BIEN LE PRODUIT ET SON FONCTIONNEMENT AINSI QUE LES RISQUES INHERENTS

NOTE: The important safeguards and instructions that appear in this manual are not meant to cover all possible conditions and situations that may occur. It must be understood that common sense, caution and care, are factors that can't be built into any product. These factors must be supplied by the person(s) caring for and operating the fixture.

Read all instructions

Do not install this fixture in hazardous locations.

N'installez pas cet appareil dans des emplacements dangereux.

Do not install any fixture assembly closer than 6 inches from any curtain or similar combustible material.

Laissez une distance d'au moins 6 pouces entre ce luminaire et la toute surface combustible.

"WARNING Risk of Fire and Electric Shock."

"CAUTION: Risque d' Incendie et de Choc Electriques."

GENERAL INFORMATION

All electrical connections must be in accordance with all ordinances, Local and the U.S. National Electrical Codes (NEC). These fixtures are intended for mounting to a standard 4" metal octagon outlet box. The box must be directly supported by the building structure and U.L. Recognized.

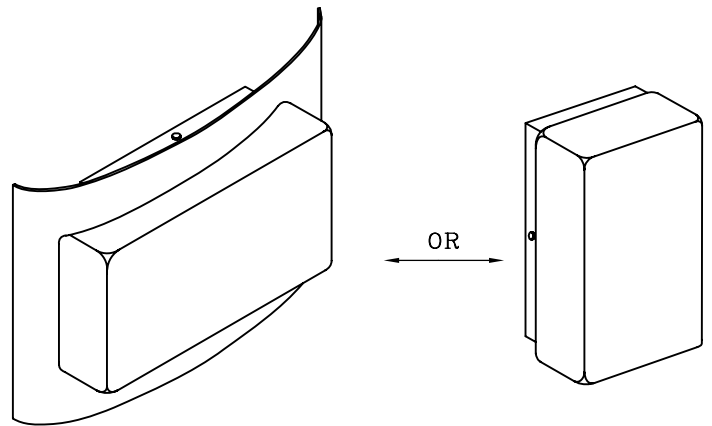

COLLECTION

Eclipse
Brick

APPLICATION

Wall Fixture
Wall Fixture

MODEL NO.

20449LEDDL/20449
20450LEDDL/20450

WHAT WE PROVIDE

- Crossbar
- Mounting Hardware
- Mounting Plate
- 1 x Glass Shade
- 1 X A19 E-26 LED Bulb (20449LEDDL)
- 1 X A19 E-26 LED Bulb (20450LEDDL)

WHAT YOU NEED

- Screwdriver
- Wire Cutters
- Wiring Supplies as Specified by Electrical Code
- 1 X A19 E-26 75W Bulb(20449)
- 1 X A19 E-26 75W Bulb(20450)

Recommended Dimmers for Supplied Bulb

(ELV) LUTRON Skylark SELV-300P
(MLV) COOPER Aspire 9530SW
(TRIAC) LEGRAND Titan CD703-PW

STEP BY STEP INSTRUCTIONS

Before starting your installation disconnect the Power by turning off the Circuit Breaker or by removing the fuse at the fuse box. Just turning the light off at the light switch is not sufficient to prevent electrical shock.

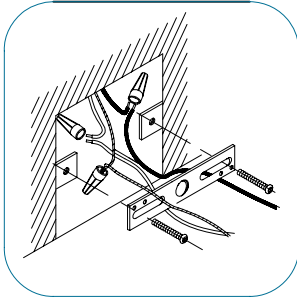

1

MOUNT CROSSBAR

If there is an existing fixture remove it. Expose the supply wires from the j-box. Mount the crossbar to the J-Box with the supplied screws.

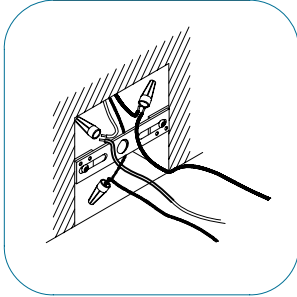

2

CONNECT THE WIRES

Connect the black supply wire to the black fixture wire. Secure with the supplied wire nuts. Connect the white supply wire to the white fixture wire. Secure with the supplied wire nuts. Attach the green J-Box wire around green hexagonal head screw or connect it to the green supply grounding wire of the fixture. Secure all wires with electrical tape (not supplied). Tuck all wires carefully into the J-Box.

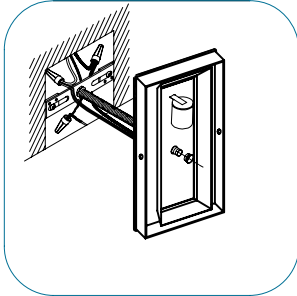

3

ATTACH THE FIXTURE TO THE CROSSBAR

Insert the nipple into the central hole of the crossbar, and adjust to suitable length. Fasten the hex nut against the nipple so that the nipple will not rotate further. Align the fixture onto the nipple and secure with supplied decorative cap nut.

NOTE: This fixture is wet location rated. In order to ensure that moisture does not enter the outlet box and cause a short circuit, clear caulking should be used to seal the space between the fixture mounting bracket and the wall. Ensure that a space is left at the bottom to allow for the escape of moisture. It is recommended that Outdoor Silicon Sealant is used for that purpose**

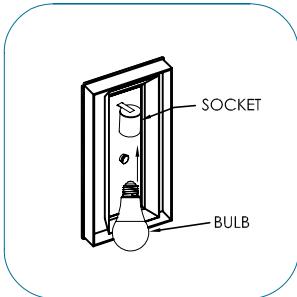

4

INSERT THE BULB

Insert the bulb.
DO NOT EXCEED THE MAXIMUM WATTAGE AS STATED ON THE WARNING LABEL

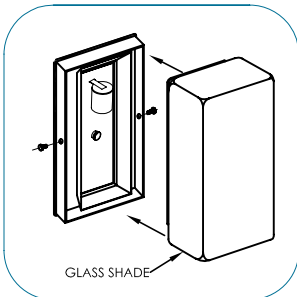

5

ATTACH THE GLASS SHADE

Place the glass shade into the back plate, and secure with the supplied screws.

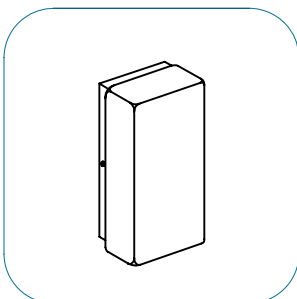

6

RESTORE THE ELECTRICITY AND CHECK THE OPERATION OF YOUR NEW ACCESS LIGHTING FIXTURE

